

Características

- Extractores axiales con hélice de aluminio fundido de perfil air-foil.
- Construidos enteramente en chapa a de acero galvanizado.
- Balanceados dinámicamente.
- Motor trifásico 220/380V, con protección IP55 (IEC-34).
- Aptos para intemperie.
- Disponible en 11 tamaños estándar.
- Motores de 4 y 6 polos.
- Transmisión directa o por poleas y correas (TAT).
- Caudales desde 300 m³/h a 17500 m³/h
- Presiones desde 3 mm c.a. a 25 mm c.a.
- Entrega rápida de 1 día.

Opcionales

- Si el cliente o la aplicación así lo requiere, todos los modelos pueden aceptar las siguientes variantes.
- construcción en chapa de acero inoxidable.
 - motor anti-exposición, motor monofásico ó motor de 2 polos.
 - hélices importadas de polipropileno y fibra de vidrio.
 - ventiladores con diámetros especiales hasta 1300 mm.

Accesorios

- Para todos los tamaños se pueden ofrecer los siguientes accesorios:
- visera anti-lluvia
 - malla metálica
 - persiana sobre-presión
 - rejillas

Características técnicas

| Modelo | Velocidad (rpm) | Caudal máx. (m ³ /h) (*) | Potencia (HP) | Peso (kg) | Nivel de ruido (dBA) (**) |
|----------|-----------------|-------------------------------------|---------------|-----------|---------------------------|
| TAD-25/6 | 910 | 400 | 1/6 | 14,6 | 39 |
| TAD-25/4 | 1400 | 650 | 1/4 | 10,9 | 48 |
| TAD-30/6 | 910 | 650 | 1/6 | 15,4 | 45 |
| TAD-30/4 | 1400 | 1050 | 1/4 | 12,4 | 54 |
| TAD-35/6 | 910 | 1100 | 1/6 | 16,4 | 49 |
| TAD-35/4 | 1400 | 1800 | 1/4 | 13,4 | 58 |
| TAD-40/6 | 910 | 1700 | 1/6 | 17,4 | 53 |
| TAD-40/4 | 1400 | 2700 | 1/4 | 14,4 | 62 |
| TAD-45/6 | 910 | 2250 | 1/6 | 19,8 | 57 |
| TAD-45/4 | 1400 | 3700 | 1/4 | 16,8 | 66 |
| TAD-50/6 | 910 | 3100 | 1/4 | 21,6 | 60 |
| TAD-50/4 | 1390 | 5000 | 1/2 | 21,6 | 69 |
| TAD-55/6 | 910 | 4100 | 1/2 | 27,4 | 60 |
| TAD-55/4 | 1415 | 6900 | 1 | 29,9 | 70 |
| TAD-60/6 | 910 | 5500 | 1/2 | 28,3 | 63 |
| TAD-60/4 | 1415 | 8900 | 1 | 30,8 | 73 |
| TAD-65/6 | 920 | 7000 | 3/4 | 34,4 | 65 |
| TAD-65/4 | 1420 | 12000 | 2 | 42,4 | 76 |
| TAD-70/6 | 920 | 8800 | 3/4 | 40,1 | 67 |
| TAD-70/4 | 1420 | 14000 | 2 | 48,1 | 78 |
| TAD-75/6 | 940 | 11000 | 1 | 46,2 | 69 |
| TAD-75/4 | 1420 | 17500 | 3 | 60,2 | 79 |

(*) en descarga libre

(**) nivel de ruido a 3 m de la boca de descarga en campo libre





Curvas características

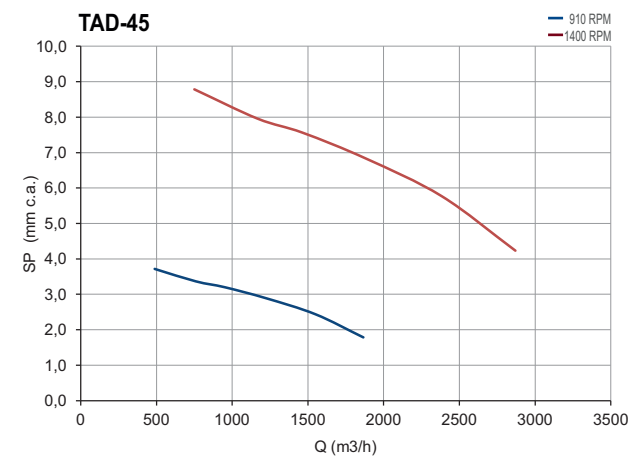
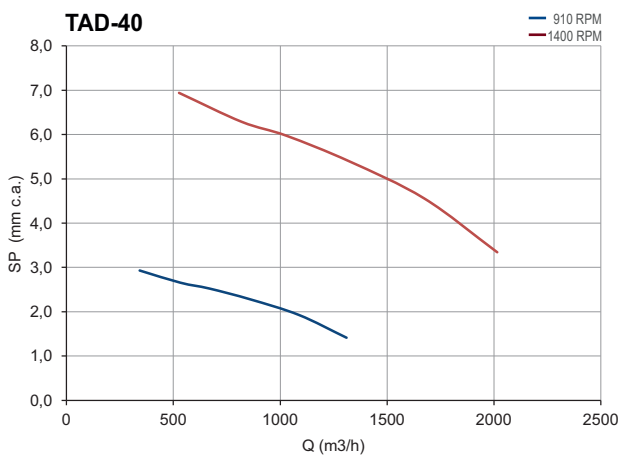
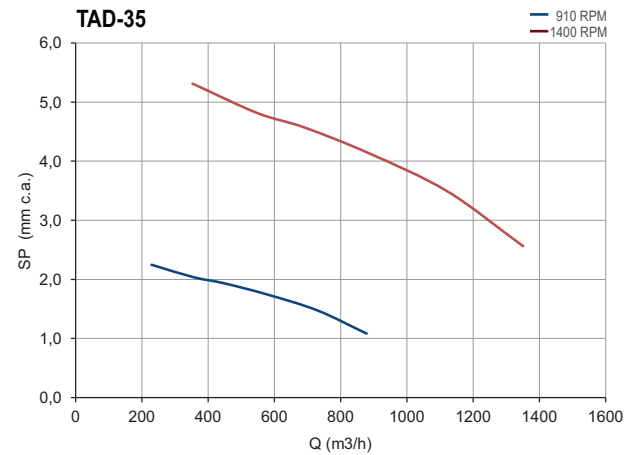
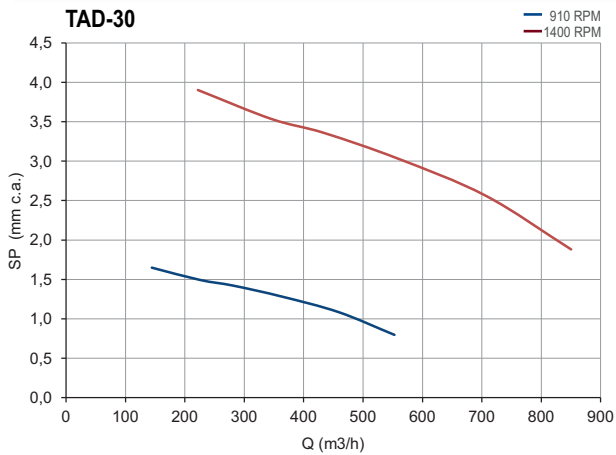
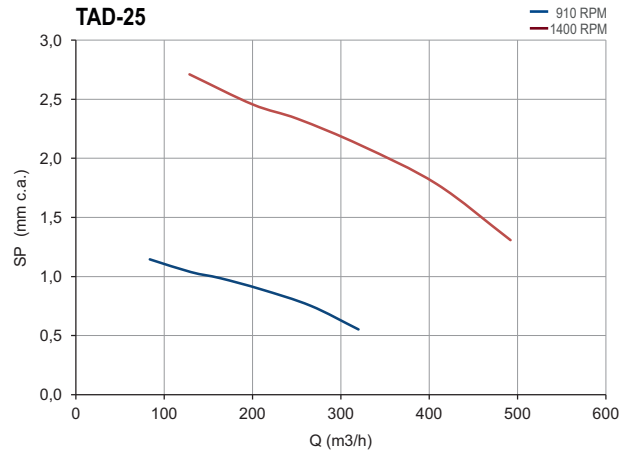



Curvas características

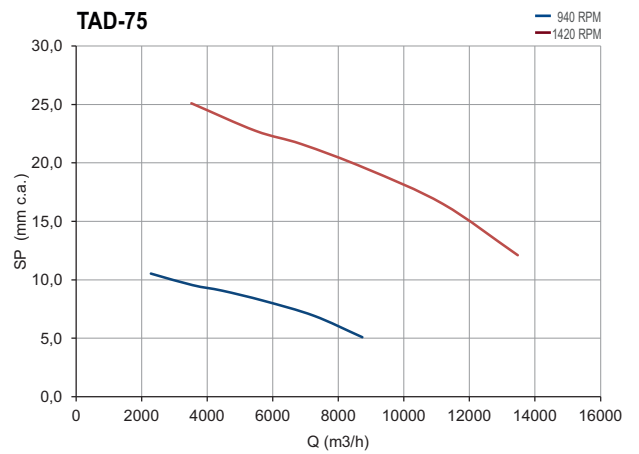
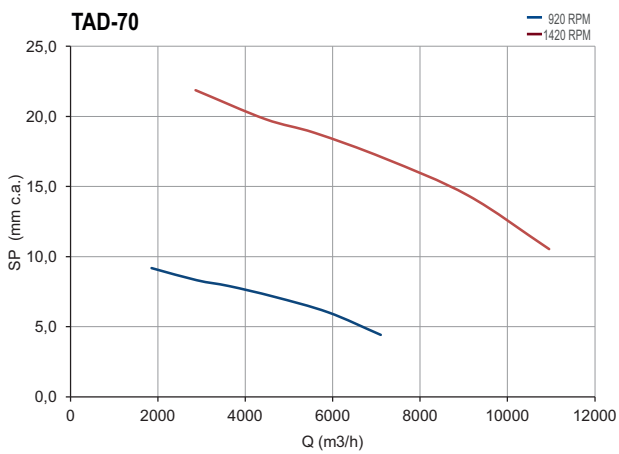
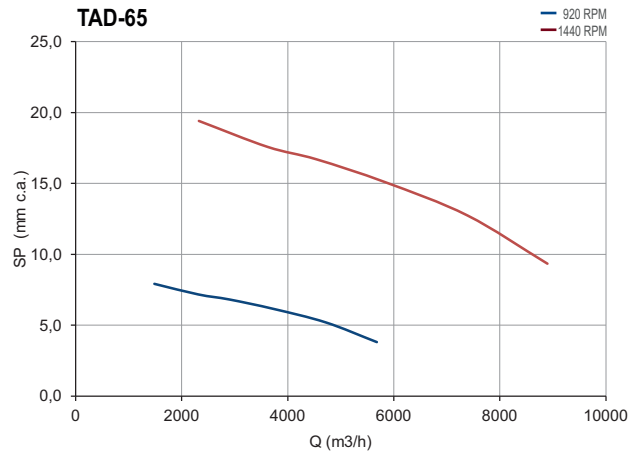
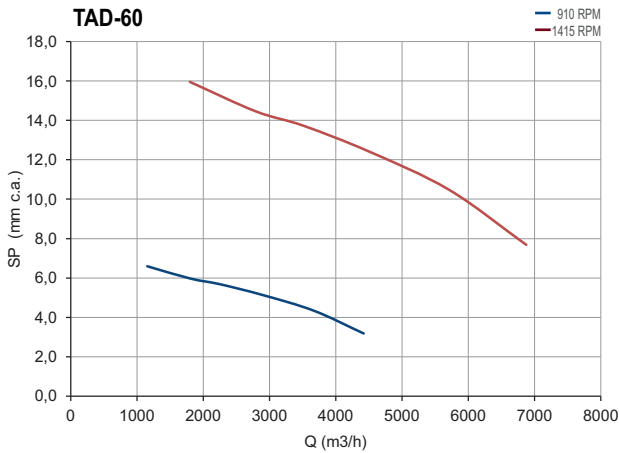
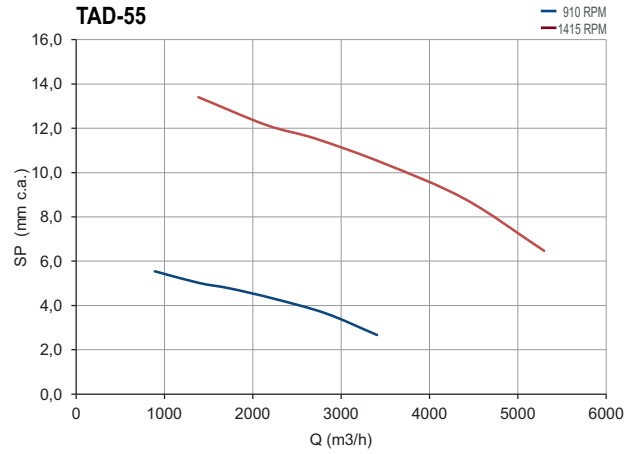
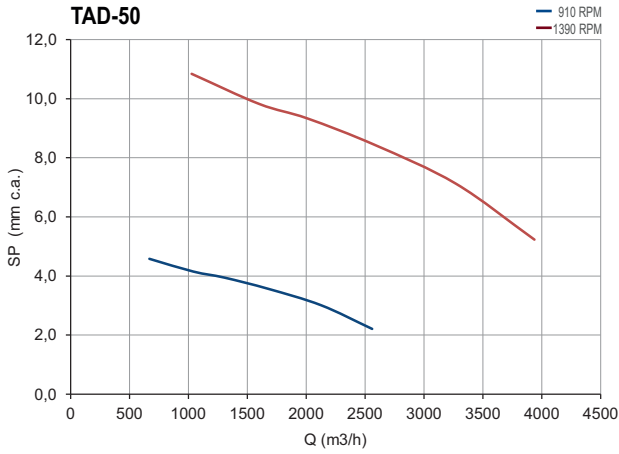

Dimensiones

| Modelo | A (mm) | B (mm) | C (mm) | D (mm) |
|--------------|--------|--------|--------|--------|
| TAD-25/6 y 4 | 250 | 286 | 210 | 48 |
| TAD-30/6 y 4 | 300 | 336 | 210 | 48 |
| TAD-35/6 y 4 | 350 | 386 | 210 | 48 |
| TAD-40/6 y 4 | 400 | 436 | 210 | 48 |
| TAD-45/6 y 4 | 450 | 486 | 210 | 48 |
| TAD-50/6 y 4 | 500 | 536 | 210 | 86 |
| TAD-55/6 y 4 | 550 | 586 | 270 | 61 |
| TAD-60/6 y 4 | 600 | 636 | 270 | 61 |
| TAD-65/6 y 4 | 650 | 686 | 300 | 59 |
| TAD-70/6 y 4 | 700 | 736 | 300 | 59 |
| TAD-75/6 y 4 | 750 | 790 | 300 | 59 |

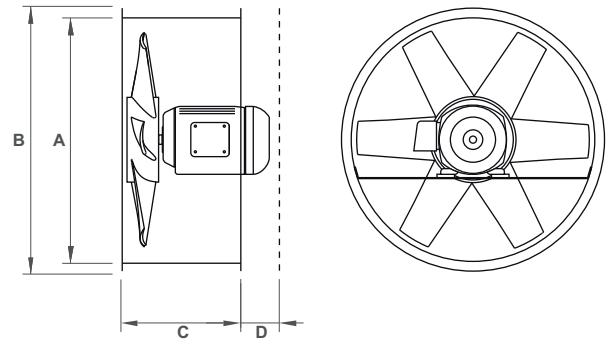

Accesorios disponibles



Malla desmontable

Malla desmontable

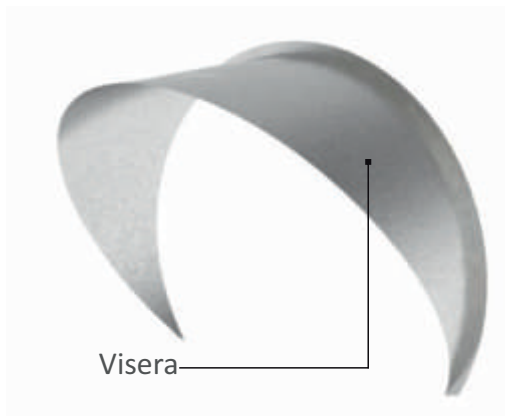

Visera

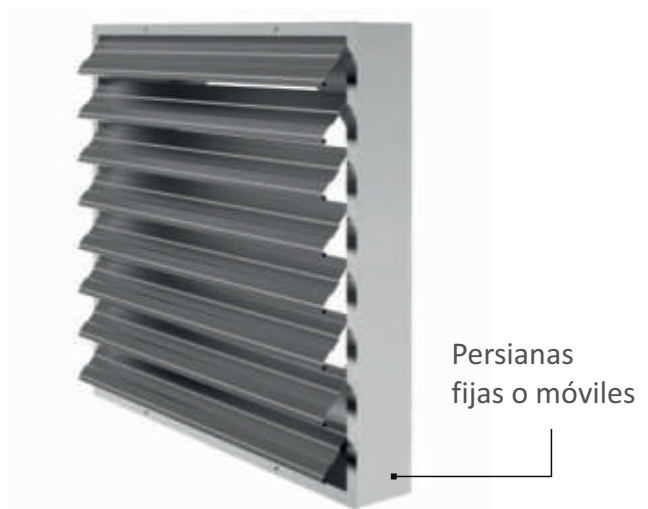

Persianas fijas o móviles